



GR-350XL-2

35 Ton Capacity (31.8 Metric Tons)

HYDRAULIC ROUGH TERRAIN CRANE

DIMENSIONS

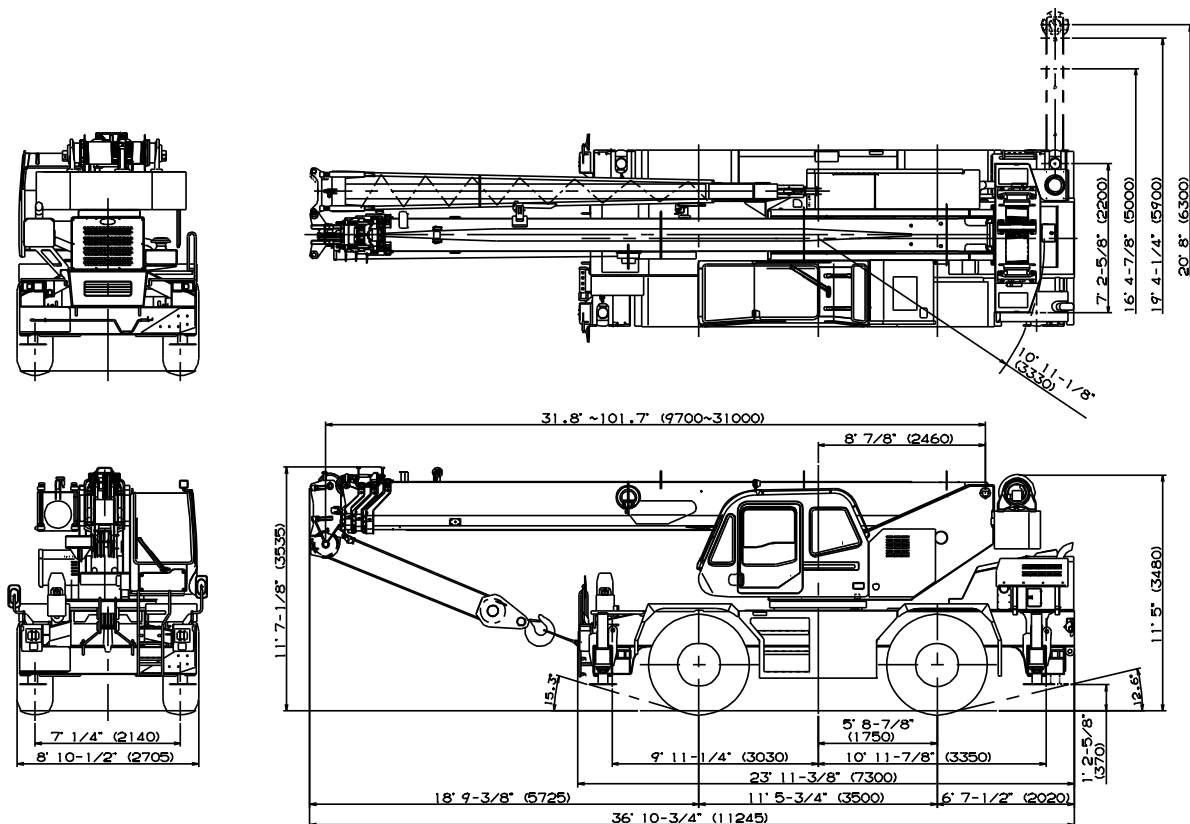

Note : Dimension is with boom angle at 0 degree.

GENERAL DIMENSIONS (20.5 - 25 Tires)

	Feet	Meters
Turning radius		
4 wheel steer	21' 4"	6.5
2 wheel steer	37' 5"	11.4
Tail swing of counterweight	10' 11-1/8"	3.33

CRANE SPECIFICATIONS

BOOM

Four section full power synchronized telescoping boom, 31.8~101.7' (9.7m~31.0m), of round hexagonal box construction with three sheaves, 13-1/4" (0.336m) root diameter, at boom head. The synchronization system consists of two telescope cylinders, an extension cable and retraction cable. Hydraulic cylinder fitted with holding valve. Two easily removable wire rope guards, rope dead end provided on both sides of boom head. Boom telescope sections are supported by wear pads both vertically and horizontally. Extension speed 69.9' in 91 seconds.

BOOM ELEVATION - By a double acting hydraulic cylinder with holding valve. Elevation 0°~81°, combination controls for hand or foot operation. Boom angle indicator. Automatic speed reduction and soft stop function. Boom raising speed 20° to 60° in 22 sec.

JIB - Two stage lattice type with 5°, 25° or 45° offset (tilt type). Single sheave, 13-7/8" (0.352m) root diameter, at jib head. Box type top section telescopes from lattice type base section which stores alongside base boom section. Jib length is 23.6' (7.2m) or 42' (12.8m).

AUXILIARY LIFTING SHEAVE (SINGLE TOP)
Single sheave, 13-1/4" (0.336m) root diameter. Mounted to main boom head for single line work (stowable).

ANTI-TWO BLOCK - Pendant type over-winding cut out device with audio-visual (FAILURE lamp/BUZZER) warning system.

SWING

Hydraulic axial piston motor through planetary swing speed reducer. Continuous 360° full circle swing on ball bearing turn table at 3.2min⁻¹ {rpm}. Equipped with manually locked/released swing brake. A 360° positive swing lock for pick and carry and travel modes, manually engaged in cab. Twin swing system: Free swing or lock swing controlled by selector switch on front console.

HOIST

MAIN HOIST - Variable speed type with grooved drum driven by hydraulic axial piston motor through speed reducer. Power load lowering and raising. Equipped with automatic brake (neutral brake) and counterbalance valve. Controlled independently of auxiliary hoist. Equipped with cable follower and drum rotation indicator.

DRUM - Grooved 12-5/8" (0.32m) root diameter x 19-1/16" (0.484m) wide. Wire rope: 558' of 5/8" diameter rope (170m of 16mm). Drum capacity: 720' (219.5m) 6 layers. Maximum single line pull: 1st layer 12,600 lbs (5,710kg). Maximum permissible line pull wire strength: 11,100 lbs (5,030kg).

AUXILIARY HOIST - Variable speed type with grooved drum driven by hydraulic axial piston motor through speed reducer. Power load lowering and raising. Equipped with automatic brake (neutral brake) and counterbalance valve. Controlled independently of main hoist. Equipped with cable follower and drum rotation indicator.

DRUM - Grooved 12-5/8" (0.32m) root diameter x 10-3/8" (0.263m) wide. Wire rope: 322' of 5/8" diameter rope (98m of 16mm). Drum capacity: 392' (119.4m) 6 layers. Maximum single line pull: 1st layer 12,600 lbs (5,710kg). Maximum permissible line pull wire strength: 13,100 lbs (5,940kg).

WIRE ROPE - Filler or warrington seal wire, extra improved plow steel, preformed, independent wire rope core, right regular lay.
Main : 5/8" (16 mm) 6x29 class
Auxiliary : 5/8" (16 mm) 6x36 class

HOOK BLOCKS

35 ton (31.8 metric ton) - 4 sheaves with swivel hook block and safety latch.
4.4 ton (4.0 metric ton) - Weighted hook ball with swivel and safety latch.

HYDRAULIC SYSTEM

PUMPS - Two variable piston pumps for crane functions. Tandem gear pump for steering, swing and optional equipment. Powered by carrier engine. Pump disconnect for crane is engaged/ disengaged by rotary switch from operator's cab.

CONTROL VALVES - Multiple valves actuated by pilot pressure with integral pressure relief valves.

RESERVOIR - 100 gallon (380 lit.) capacity. External sight level gauge.

FILTRATION - BETA10=10 return filter, full flow with bypass protection, located inside of hydraulic reservoir. Accessible for easy replacement.

OIL COOLER - Air cooled fan type.

CAB AND CONTROLS

Both crane and drive operations can be performed from one cab mounted on rotating superstructure.

Left side, 1 man type, steel construction with sliding door access and safety glass windows opening at side. Door window is powered control. Windshield glass window and roof glass window are shatter-resistant. Tilt-telescoping steering wheel. Adjustable control lever stands for swing, boom elevating, boom telescoping, auxiliary hoist and main hoist. Control lever stands can change neutral positions and tilt for easy access to cab. 3 way adjustable operator's seat with high back, headrest and armrest. Engine throttle knob. Foot operated controls: boom elevating, boom telescoping, service brake and engine throttle. Hot water cab heater and air conditioning.

Dash-mounted engine start/stop, monitor lamps, cigarette lighter, drive selector switch, parking brake switch, steering mode select switch, power window switch, pump engaged/disengaged switch, swing brake switch, telescoping/auxiliary hoist select switch, outrigger controls, free swing / lock swing selector switch, eco mode switch and ashtray.

Instruments - Torque converter oil temperature, engine water temperature, air pressure, fuel, speedometer, tachometer, hour meter and odometer / tripmeter. Hydraulic oil pressure is monitored and displayed on the AML-C display panel.

Tadano electronic LOAD MOMENT INDICATOR system (AML-C) including:

- Control lever lockout function
- Boom position indicator
- Outrigger state indicator
- Boom angle / boom length / jib offset angle / jib length / load radius / rated lifting capacities / actual loads read out
- Ratio of actual load moment to rated load moment indication
- Automatic Speed Reduction and Slow Stop function on boom elevation and swing
- Working condition register switch
- Load radius / boom angle / tip height / swing range preset function
- External warning lamp
- Tare function
- Fuel consumption monitor
- Main hoist / auxiliary hoist select
- Drum rotation indicator (audible and visible type) main and auxiliary hoist

TADANO AML-C monitors outrigger extended length and automatically programs the corresponding "RATED LIFTING CAPACITIES" table

Operator's right hand console includes transmission gear selector and sight level bubble. Upper console includes working light switch, roof washer and wiper switch emergency outrigger set up key switch, jib equipped/removed select switch, eco mode switch, and air conditioning control switch. Swing lock lever.

NOTE: Each crane motion speed is based on unladen conditions.

CARRIER SPECIFICATIONS

TYPE - Rear engine, left hand steering, driving axle 2-way selected type by manual switch, 4x2 front drive, 4x4 front and rear drive.

FRAME - High tensile steel, all welded mono-box construction.

TRANSMISSION - Electronically controlled full automatic transmission. Torque converter driving full powershift with driving axle selector. 6 forward and 2 reverse speeds, constant mesh.

- 4 speeds - high range - 2 wheel drive; 4 wheel drive
- 4 speeds - low range - 4 wheel drive

TRAVEL SPEED - 31 mph (50 km/h)

AXLE - Front: Full floating type, steering and driving axle with planetary reduction. Rear: Full floating type, steering and driving axle with planetary reduction and non-spin rear differential.

STEERING - Hydraulic power steering controlled by steering wheel. Three steering modes available: 2 wheel front, 4 wheel coordinated and 4 wheel crab .

SUSPENSION - Front: Semi-elliptic leaf springs with hydraulic lockout device. Rear: Semi-elliptic leaf springs with hydraulic lockout device.

BRAKE SYSTEMS - Service: Air over hydraulic disc brakes on all 4 wheels. Parking/Emergency: Spring applied-air released brake acting on input shaft of front axle. Auxiliary: Electro-pneumatic operated exhaust brake.

TIRES - 20.5-25(OR)

OUTRIGGERS - Four hydraulic, beam and jack outriggers. Vertical jack cylinders equipped with integral holding valve. Each outrigger beam and jack is controlled independently from cab. Beams extend to 20' 8" (6.3 m) center-line and retract to within 8' 10-1/2" (2.705 m) overall width with floats. Outrigger jack floats are attached thus eliminating the need of manually attaching and detaching them. Controls and sight bubble located in superstructure cab. Four outrigger extension lengths are provided with corresponding "RATED LIFTING CAPACITIES" for crane duty in confined areas.

- Min. Extension 7' 2-5/8" (2.2m) center to center
- Mid. Extension 16' 4-7/8" (5.0m) center to center
- Mid. Extension 19' 4-1/4" (5.9m) center to center
- Max. Extension 20' 8" (6.3m) center to center
- Float size(Diameter) 1' 3- 3/4" (0.4m)

ENGINE

Model	Cummins QSB6.7 [Tier 4]
Type	Direct injection diesel
No. of cylinders	6
Combustion	4 cycle, turbo charged and after cooled
BoreXStroke, in.(mm)	4.212 X 4.882 (107X124)
Displacement, cu. in (liters)	409 (6.700)
Air inlet heater	24 volt preheat
Air cleaner	Dry type, replaceable element
Oil filter	Full flow with replaceable element
Fuel filter	Full flow with replaceable element
Fuel tank, gal.(liters)	79.2 (300), right side of carrier
Cooling	Liquid pressurized, recirculating by-pass

Radiator	Fin and tube core, thermostat controlled
Fan, in.(mm)	Suction type, 9-blade, 28 (711) dia.
Starting	24 volt
Charging	24 volt system, negative ground
Battery	2-120 amp. Hour
Compressor, air, CFM(l /min)	17.0 CFM (481) at 2,400rpm
Output, Max. HP (kW)	Gross 220 (160) at 2,500rpm
Torque, Max. ft-lb (Nm)	622 (843) at 1,600rpm
Capacity, gal.(liters)	
Cooling water	2.7 (10)
Lubrication	4.0 (15)
Fuel	79.2 (300)

STANDARD EQUIPMENT

- Four section full power partially synchronized boom 31.8'-101.7' (9.7 m-31.0 m)
- 23.6' or 42' (7.2 m or 12.8 m) lattice jib (tilt type) with 5°, 25° or 45° pinned offsets and self storing pins.
- Auxiliary lifting sheave (single top) stowable
- Variable speed main hoist with grooved drum, cable follower and 558' of 5/8" cable.
- Variable speed auxiliary hoist with grooved drum, cable follower and 322' of 5/8" cable.
- Drum rotation indicator (audible, visible and thumper type) main and auxiliary hoist
- Anti-Two block device (overwind cutout)
- Boom angle indicator
- Tadano electronic load moment indicator system (AML-C)
- Outrigger extension length detector
- Electronic crane monitoring system
- Tadano twin swing system and 360° positive swing lock
- Self centering finger control levers with pilot control
- Control pedals for boom elevating and boom telescoping
- 3 way adjustable cloth seat with armrests, high back and seat belt
- Tilt-telescoping steering wheel
- Tinted safety glass and sun visor
- Front windshield wiper and washer
- Roof window wiper and washer
- Power window (cab door)
- Rear view mirrors (right and left side)
- Cigarette lighter and ashtray
- Cab floor mat
- Pump disconnect in operator's cab
- Hydraulic oil cooler
- Hot water cab heater and air conditioner
- Positive control
- Work lights
- Independently controlled outriggers
- Four outrigger extension positions
- Self-storing outrigger pads
- Cummins QSB6.7 turbo charged after cooled engine (220HP) with exhaust brake
- Electronic controlled automatic transmission driven by torque converter
- 4 X 4 X 4 drive/steer
- Non-spin rear differential
- Semi-elliptic leaf springs suspension with hydraulic lockout device (front and rear)
- 20.5-25(OR) tires
- Disc brakes
- Fenders
- Air dryer
- Water separator with filter (high filtration)
- Engine over-run alarm
- Back-up alarm
- Low oil pressure/high water temp. warning device (visual)
- Rear steer centering light
- Air cleaner dust indicator
- Full instrumentation package
- Complete highway light package
- Tool storage compartment
- Tire inflation kit
- 24 volt electric system
- 4.4 ton (4.0 metric ton) hook ball with swivel
- 35 ton (31.8 metric ton) - 4 sheaves with swivel hook block and safety latch for 5/8" (16mm) wire rope
- Towing hooks-Front and rear
- Lifting eyes
- Hook block tie down (front bumper)
- Weighted hook storage compartment
- Halogen head lamp
- Telematics (machine data logging and monitoring system) with HELLO-NET via internet
- Fuel consumption monitor
- Eco mode system

HOISTING PERFORMANCE

LINE SPEEDS AND PULLS

Layer	Main or auxiliary hoist - 12'-5/8" (0.32m) drum			
	Line speeds ¹		Line pulls Available ²	
	F.P.M.	m/min	Lbs.	kgf
1st	328	100	12600	5710
2nd	354	108	11500	5210
3rd	384	117	10500	4760
4th	410	125	9700	4400
5th	436	133	9000	4080
6th ³	466	142	8400	3800

DRUM WIRE ROPE CAPACITIES

Wire rope layer	Main drum grooved lagging				Auxiliary drum grooved lagging			
	5/8" (16mm) wire rope							
	Rope per layer		Total wire rope		Rope per layer		Total wire rope	
	Feet	Meters	Feet	Meters	Feet	Meters	Feet	Meters
1	98.8	30.1	98.8	30.1	53.8	16.4	53.8	16.4
2	107.6	32.8	206.4	62.9	58.4	17.8	112.2	34.2
3	115.8	35.3	322.2	98.2	63.0	19.2	175.2	53.4
4	124.0	37.8	446.2	136.0	67.6	20.6	242.8	74.0
5	132.9	40.5	579.1	176.5	72.2	22.0	315.0	96.0
6	141.0	43.0	720.1	219.5	76.7	23.4	391.7	119.4

* Maximum permissible line pull may be affected by wire rope strength.
 Wire rope strength Main : (6x29 class) = 11,100lbs (5,030kg)
 Auxiliary : (6x36 class) = 13,100lbs (5,940kg)

- Line speeds based only on hook block, not loaded.
- Developed by machinery with each layer of wire rope, but not based on rope strength or other limitation in machinery or equipment.
- Sixth layer of wire rope are not recommended for hoisting operations.

DRUM DIMENSIONS

	Inch	mm
Root diameter	12-5/8"	320
Length	Main	19-1/16"
	Auxiliary	10-3/8"
Flange diameter	20-7/8"	530

GR-350XL WORKING RANGE CHART

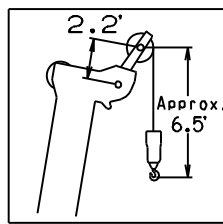
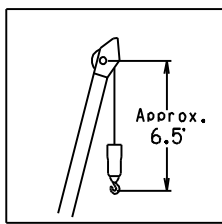
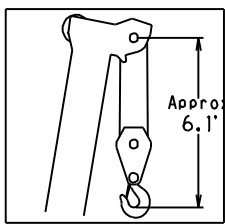
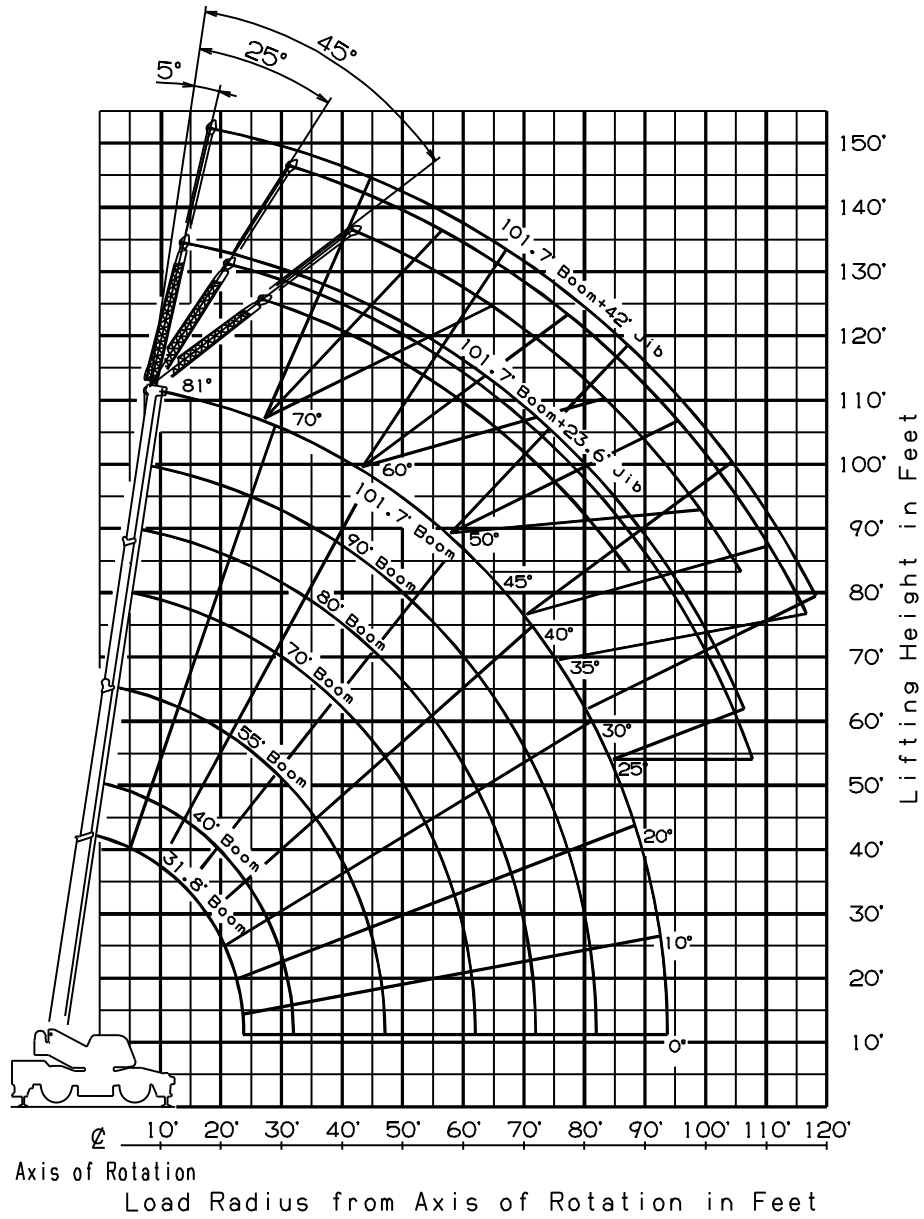

NOTE: 1. Boom and jib geometry shown are for unloaded condition and machine standing level on firm supporting surface. Boom deflection and subsequent radius and boom angle change must be accounted for when applying load to hook.

Boom Length in Feet

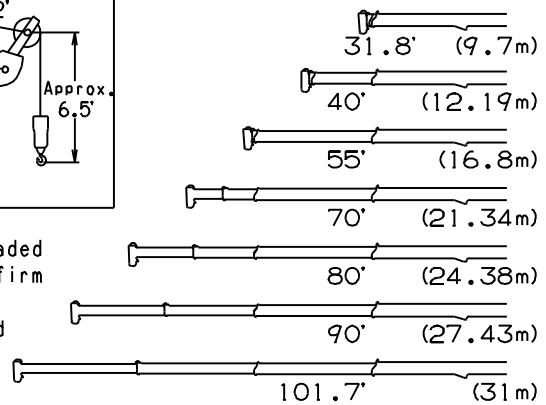

GR-350XL RATED LIFTING CAPACITIES (IN POUNDS)

ON OUTRIGGERS FULLY EXTENDED 20' 8"(6.3m) SPREAD														
360° ROTATION														
B \ A	31.8'		40'		55'		70'		80'		90'		101.7'	
	C	(9.7m)	C	(12.19m)	C	(16.8m)	C	(21.34m)	C	(24.38m)	C	(27.43m)	C	(31m)
8'	65	70,000												
10'	60	60,000	67	49,600	74	42,300	78	27,500						
12'	56	56,500	64	49,600	72	42,300	76	27,500	78	27,500				
15'	49	46,500	59	46,000	69	40,000	74	27,500	76	27,500	78	25,300		
20'	34	36,000	50	35,500	63	32,000	69	27,500	72	27,200	75	23,500	77	18,500
25'			38	28,500	57	25,900	65	24,200	69	22,700	72	20,400	75	18,100
30'			22	20,500	50	20,100	60	20,100	65	19,400	68	17,800	72	16,300
35'					42	15,800	55	16,700	60	16,000	65	15,300	68	14,400
40'					33	12,200	50	13,100	56	13,250	61	13,050	65	12,600
45'					19	9,250	44	10,300	51	10,600	57	11,000	62	11,000
50'							37	8,400	46	8,700	53	8,900	59	9,300
55'							29	6,650	41	7,100	49	7,300	55	7,800
60'							16	5,400	34	5,900	44	6,200	51	6,450
65'									27	4,800	39	5,100	47	5,300
70'									15	3,700	33	4,300	43	4,400
75'											25	3,650	38	3,800
80'											15	3,000	33	3,200
85'													27	2,600
90'													18	2,200
D														0

LIFTING CAPACITIES AT ZERO DEGREE BOOM ANGLE ON OUTRIGGERS FULLY EXTENDED														
20' 8"(6.3m) SPREAD 360° ROTATION														
C \ A	31.8'		40'		55'		70'		80'		90'		101.7'	
	B	(9.7m)	B	(12.19m)	B	(16.8m)	B	(21.34m)	B	(24.38m)	B	(27.43m)	B	(31m)
0°	23.7'	30,400	31.9'	18,700	46.9'	8,600	61.9'	5,000	71.9'	3,400	81.9'	2,800	93.6'	1,900

ON OUTRIGGERS MID EXTENDED 19' 4-1/4"(5.9m) SPREAD														
360° ROTATION														
B \ A	31.8'		40'		55'		70'		80'		90'		101.7'	
	C	(9.7m)	C	(12.19m)	C	(16.8m)	C	(21.34m)	C	(24.38m)	C	(27.43m)	C	(31m)
8'	65	70,000												
10'	60	60,000	67	49,600	74	42,300	78	27,500						
12'	56	56,500	64	49,600	72	42,300	76	27,500	78	27,500				
15'	49	46,500	59	46,000	69	40,000	74	27,500	76	27,500	78	25,300		
20'	34	34,700	50	35,500	63	32,000	69	27,500	72	27,200	75	23,500	77	18,500
25'			38	24,000	57	23,700	65	24,200	69	22,700	72	20,400	75	18,100
30'			22	16,700	50	16,500	60	17,900	65	18,300	68	17,300	72	16,300
35'					42	12,250	55	13,400	60	13,850	65	14,150	68	13,250
40'					33	9,050	49	10,300	56	10,700	61	11,200	65	11,200
45'					19	6,750	43	8,000	51	8,350	57	8,800	62	9,100
50'							37	6,300	46	6,700	53	7,050	58	7,300
55'							29	4,850	41	5,300	48	5,700	55	6,000
60'							16	3,800	34	4,200	44	4,600	51	4,800
65'									27	3,300	38	3,700	47	4,000
70'									15	2,600	33	2,900	43	3,200
75'											25	2,300	38	2,600
80'											15	1,700	33	2,000
85'													26	1,400
90'													18	800
D														0

LIFTING CAPACITIES AT ZERO DEGREE BOOM ANGLE ON OUTRIGGERS MID EXTENDED														
19' 4-1/4"(5.9m) SPREAD 360° ROTATION														
C \ A	31.8'		40'		55'		70'		80'		90'		101.7'	
	B	(9.7m)	B	(12.19m)	B	(16.8m)	B	(21.34m)	B	(24.38m)	B	(27.43m)	B	(31m)
0°	23.7'	26,500	31.9'	15,000	46.9'	6,000	61.9'	3,400	71.9'	2,300	81.9'	1,450	93.6'	500

- A : Boom length in feet
- B : Load radius in feet
- C : Loaded boom angle (°)
- D : Minimum boom angle (°) for indicated length (no load)

NOTE: The lifting capacity data stored in the LOAD MOMENT INDICATOR (AML-C) is based on the standard number of parts of line listed in the chart. Standard number of parts of line for each boom length should be according to the following table.

Boom length in feet (meters)	31.8' (9.7m)	31.8' to 55' (9.7m to 16.8m)	55' to 101.7' (16.8m to 31.0m)	Single top Jib
Number of parts of line	8	6	4	1

GR-350XL RATED LIFTING CAPACITIES (IN POUNDS)

ON OUTRIGGERS MID EXTENDED 16' 4-7/8"(5.0m) SPREAD														
360° ROTATION														
B \ A	31.8' (9.7m)		40'		55'		70'		80'		90'		101.7'	
	C	C	C	C	C	C	C	C	C	C	C	C	C	C
8'	65	70,000												
10'	60	60,000	67	49,600	74	42,300	78	27,500						
12'	56	56,500	64	49,600	72	42,300	76	27,500	78	27,500				
15'	49	46,500	59	46,000	69	40,000	74	27,500	76	27,500	78	25,300		
20'	34	28,300	50	27,600	63	27,000	69	27,500	73	27,200	75	23,500	77	18,500
25'			38	18,300	56	17,800	65	19,200	69	19,600	72	19,900	75	18,100
30'			22	12,700	50	12,700	60	13,800	64	14,200	68	14,750	72	15,000
35'					42	9,000	55	10,000	60	10,500	64	11,000	68	11,300
40'					32	6,500	49	7,500	56	8,000	61	8,400	65	8,700
45'					19	4,700	43	5,700	51	6,200	57	6,500	62	6,800
50'							37	4,300	46	4,700	53	5,100	58	5,400
55'							28	3,200	40	3,600	48	4,000	55	4,300
60'							16	2,300	34	2,700	43	3,100	51	3,400
65'									26	2,000	38	2,400	47	2,600
70'									15	1,300	32	1,700	42	2,000
75'											25	1,200	38	1,400
80'													32	1,000
D	0												20	

LIFTING CAPACITIES AT ZERO DEGREE BOOM ANGLE ON OUTRIGGERS MID EXTENDED												
16' 4-7/8"(5.0m) SPREAD 360° ROTATION												
C \ A	31.8' (9.7m)		40'		55'		70'		80'		90'	
	B	B	B	B	B	B	B	B	B	B	B	B
0°	23.7'	20,700	31.9'	11,300	46.9'	4,100	61.9'	2,100	71.9'	1,100	81.9'	500

ON OUTRIGGERS MIN EXTENDED 7' 2-5/8"(2.2m) SPREAD														
360° ROTATION														
B \ A	31.8' (9.7m)		40'		55'		70'		80'		90'		101.7'	
	C	C	C	C	C	C	C	C	C	C	C	C	C	C
8'	65	44,400												
10'	60	28,600	67	27,500	74	27,900	78	27,500						
12'	56	20,900	64	20,800	72	20,300	76	21,600	78	22,700				
15'	49	14,600	59	14,100	68	13,800	73	15,000	76	15,600	78	16,500		
20'	33	7,900	49	8,200	62	7,700	69	8,900	72	9,400	74	10,000	77	10,300
25'			38	4,900	56	4,500	64	5,600	68	6,000	71	6,500	74	6,700
30'			22	2,600	49	2,300	59	3,400	64	3,800	67	4,200	70	4,400
35'					42	1,000	54	1,900	60	2,300	64	2,600	67	2,900
40'									55	1,200	60	1,500	64	1,800
D	0		36		45		51		54		58			

LIFTING CAPACITIES AT ZERO DEGREE BOOM ANGLE ON OUTRIGGERS MIN EXTENDED												
7' 2-5/8"(2.2m) SPREAD 360° ROTATION												
C \ A	31.8' (9.7m)		40'									
	B	B	B	B								
0°	23.7'	5,600	31.9'	2,000								

- A : Boom length in feet
- B : Load radius in feet
- C : Loaded boom angle (°)
- D : Minimum boom angle (°) for indicated length (no load)

NOTE: The lifting capacity data stored in the LOAD MOMENT INDICATOR (AML-C) is based on the standard number of parts of line listed in the chart.
Standard number of parts of line for each boom length should be according to the following table.

Boom length in feet (meters)	31.8' (9.7m)	31.8' to 55' (9.7m to 16.8m)	55' to 101.7' (16.8m to 31.0m)	Single top Jib
Number of parts of line	8	6	4	1

GR-350XL RATED LIFTING CAPACITIES (IN POUNDS)

ON OUTRIGGERS FULLY EXTENDED 20' 8"(6.3m) SPREAD 360° ROTATION													
C	101.7' (31m) Boom + 23.6' (7.2m) Jib						C	101.7' (31m) Boom + 42' (12.8m) Jib					
	5° offset		25° offset		45° offset			5° offset		25° offset		45° offset	
	R	W	R	W	R	W		R	W	R	W	R	W
80	19.3'	7,700	26.7'	5,200	32.1'	3,700	80	25.6'	4,800	38.0'	2,600	47.8'	1,700
77.5	25.2'	7,700	32.0'	5,000	37.2'	3,600	77.5	32.2'	4,800	44.3'	2,600	53.4'	1,700
75	30.8'	7,700	37.5'	4,800	42.4'	3,500	75	38.8'	4,800	50.4'	2,600	58.6'	1,700
72.5	36.4'	7,350	42.7'	4,600	47.1'	3,400	72.5	44.9'	4,400	56.1'	2,450	63.9'	1,700
70	41.8'	7,000	47.7'	4,400	52.1'	3,300	70	50.9'	4,000	61.6'	2,300	68.9'	1,650
67.5	47.0'	6,600	52.9'	4,250	56.6'	3,200	67.5	56.8'	3,700	67.1'	2,200	73.9'	1,600
65	52.0'	6,200	57.5'	4,100	61.0'	3,150	65	62.3'	3,400	72.2'	2,050	78.5'	1,600
62.5	56.8'	5,700	62.4'	3,950	65.2'	3,100	62.5	67.9'	3,150	77.4'	1,950	83.0'	1,550
60	61.4'	5,200	66.8'	3,800	69.5'	3,050	60	73.1'	2,900	82.1'	1,850	87.3'	1,500
57.5	65.8'	4,700	71.2'	3,650	73.4'	3,000	57.5	78.6'	2,750	86.7'	1,800	91.4'	1,450
55	70.3'	4,200	75.3'	3,500	77.4'	2,900	55	83.5'	2,600	91.4'	1,750	95.4'	1,400
52.5	74.3'	3,700	79.2'	3,300	81.0'	2,800	52.5	88.3'	2,450	95.9'	1,700	99.0'	1,400
50	78.4'	3,200	82.9'	3,100	84.5'	2,650	50	93.0'	2,300	99.8'	1,600	102.0'	1,350
47.5	82.2'	2,900	86.2'	2,750	87.9'	2,500	47.5	97.4'	2,100	104.0'	1,550	106.0'	1,350
45	85.8'	2,600	89.6'	2,400	90.9'	2,400	45	102.0'	1,900	107.0'	1,500	110.0'	1,350
42.5	89.3'	2,300	92.8'	2,150			42.5	105.0'	1,700	111.0'	1,400		
40	92.6'	2,000	95.7'	1,900			40	109.0'	1,500	114.0'	1,300		
37.5	95.7'	1,750	98.6'	1,650			37.5	113.0'	1,350	117.0'	1,150		
35	98.6'	1,500	101.0'	1,400			35	116.0'	1,200	120.0'	1,000		
32.5	101.0'	1,350	104.0'	1,250			32.5	119.0'	1,050				
30	104.0'	1,200	106.0'	1,100			30	122.0'	900				
27.5	106.0'	1,050	108.0'	1,000									
25	108.0'	900	110.0'	900									

C :Loaded boom angle (°)

R :Load radius in feet

W :Rated lifting capacity in pounds

GR-350XL RATED LIFTING CAPACITIES (IN POUNDS)

ON OUTRIGGERS MID EXTENDED 19' 4-1/4"(5.9m) SPREAD													
360° ROTATION													
C	101.7' (31m) Boom + 23.6' (7.2m) Jib							101.7' (31m) Boom + 42' (12.8m) Jib					
	5° offset		25° offset		45° offset			5° offset		25° offset		45° offset	
	R	W	R	W	R	W		R	W	R	W	R	W
80	19.3'	7,700	26.7'	5,200	32.1'	3,700	80	25.6'	4,800	38.0'	2,600	47.8'	1,700
77.5	25.2'	7,700	32.0'	5,000	37.2'	3,600	77.5	32.2'	4,800	44.3'	2,600	53.4'	1,700
75	30.8'	7,700	37.5'	4,800	42.4'	3,500	75	38.8'	4,800	50.4'	2,600	58.6'	1,700
72.5	36.4'	7,350	42.7'	4,600	47.1'	3,400	72.5	44.9'	4,400	56.1'	2,450	63.9'	1,700
70	41.8'	7,000	47.7'	4,400	52.1'	3,300	70	50.9'	4,000	61.6'	2,300	68.9'	1,650
67.5	47.1'	6,600	52.9'	4,250	56.6'	3,200	67.5	56.8'	3,700	67.1'	2,200	73.9'	1,600
65	52.1'	6,200	57.5'	4,100	61.0'	3,150	65	62.3'	3,400	72.2'	2,050	78.5'	1,600
62.5	56.7'	5,700	62.3'	3,950	65.4'	3,100	62.5	67.9'	3,150	77.4'	1,950	83.0'	1,550
60	61.1'	5,200	66.6'	3,800	69.5'	3,050	60	73.1'	2,900	82.1'	1,850	87.3'	1,500
57.5	65.6'	4,350	70.7'	3,500	73.5'	2,950	57.5	78.2'	2,700	86.9'	1,800	91.4'	1,450
55	69.9'	3,500	74.8'	3,200	77.2'	2,850	55	82.9'	2,500	91.2'	1,750	95.4'	1,400
52.5	74.0'	2,950	78.6'	2,750	80.9'	2,550	52.5	87.7'	2,150	95.7'	1,650	99.0'	1,350
50	78.0'	2,400	82.4'	2,300	84.2'	2,200	50	92.1'	1,850	99.8'	1,500	103.0'	1,300
47.5	81.8'	2,050	86.0'	1,950	87.6'	1,900	47.5	96.5'	1,550	104.0'	1,350	106.0'	1,200
45	85.3'	1,750	89.5'	1,650	90.7'	1,650	45	101.0'	1,300	107.0'	1,200	109.0'	1,100
42.5	88.9'	1,500	92.6'	1,350									
40	92.2'	1,200	95.6'	1,100									

ON OUTRIGGERS MID EXTENDED 16' 4-7/8"(5.0m) SPREAD													
360° ROTATION													
C	101.7' (31m) Boom + 23.6' (7.2m) Jib							101.7' (31m) Boom + 42' (12.8m) Jib					
	5° offset		25° offset		45° offset			5° offset		25° offset		45° offset	
	R	W	R	W	R	W		R	W	R	W	R	W
80	19.3'	7,700	26.7'	5,200	32.1'	3,700	80	25.6'	4,800	38.0'	2,600	47.8'	1,700
77.5	25.2'	7,700	32.0'	5,000	37.2'	3,600	77.5	32.2'	4,800	44.3'	2,600	53.4'	1,700
75	30.8'	7,700	37.5'	4,800	42.4'	3,500	75	38.8'	4,800	50.4'	2,600	58.6'	1,700
72.5	36.4'	7,100	42.7'	4,600	47.1'	3,400	72.5	44.9'	4,400	56.1'	2,450	63.9'	1,700
70	41.5'	6,500	47.7'	4,400	52.1'	3,300	70	50.9'	4,000	61.6'	2,300	68.9'	1,650
67.5	46.7'	5,950	52.7'	4,350	56.6'	3,200	67.5	56.8'	3,700	67.1'	2,200	73.9'	1,600
65	51.5'	5,400	57.5'	4,100	61.0'	3,100	65	62.3'	3,400	72.2'	2,050	78.5'	1,600
62.5	56.1'	4,500	61.8'	3,650	65.2'	3,000	62.5	67.5'	3,050	77.4'	1,950	83.0'	1,500
60	60.5'	3,600	66.2'	3,200	69.3'	2,950	60	72.7'	2,750	82.1'	1,850	87.1'	1,400
57.5	64.8'	3,000	70.5'	2,700	73.1'	2,500	57.5	77.6'	2,250	86.6'	1,600	91.3'	1,400
55	69.2'	2,400	74.4'	2,200	76.9'	2,100	55	82.4'	1,750	90.9'	1,400	95.0'	1,400
52.5	73.4'	2,050	78.3'	1,750	80.3'	1,750	52.5	86.8'	1,400	95.1'	1,200	99.1'	1,200
50	77.2'	1,650	81.9'	1,400	83.8'	1,400	50	91.2'	1,100	99.4'	1,000	102.4'	1,000
47.5	81.4'	1,350											
45	85.0'	1,000											

C :Loaded boom angle (°)
R :Load radius in feet
W :Rated lifting capacity in pounds

WARNING AND OPERATING INSTRUCTIONS FOR LIFTING CAPACITIES

GENERAL

1. RATED LIFTING CAPACITIES apply only to the machine as originally manufactured and normally equipped by TADANO LTD. Modifications to the machine or use of optional equipment other than that specified can result in a reduction of capacity.
2. Hydraulic cranes can be hazardous if improperly operated or maintained. Operation and maintenance of this machine must be in compliance with information in the **Operation and Maintenance Manual** supplied with the crane. If this manual is missing, order a replacement through the distributor.
3. The operator and other personnel associated with this machine shall fully acquaint themselves with the latest applicable ASME B30.5 safety standards for cranes as mentioned in OSHA CFR29 part 1926.

SET UP

1. Rated lifting capacities on the load chart are the maximum allowable crane capacities. They are based on the machine standing level on firm supporting surface under ideal job conditions. Depending on the nature of the supporting surface, it may be necessary to have structural supports under the outrigger floats or tires to spread the loads to a larger surface.
2. For outrigger operation, outriggers shall be properly extended with tires free of supporting surface before operating crane.

OPERATION

1. Rated lifting capacities have been tested to and meet minimum requirements of SAE J1063-Cantilevered Boom Crane Structures Method of Test.
2. Rated lifting capacities do not exceed 85 % of the tipping load on outriggers fully extended as determined by SAE J765-Crane Stability Test Code.
Rated lifting capacities for partially extended outriggers are determined from the formula, Rated Lifting Capacities = (Tipping Load - 0.1 x Tip Reaction)/1.25.
3. Rated lifting capacities above bold lines in the chart are based on crane strength and those below, on its stability. They are based on actual load radius increased by boom deflection.
4. The weight of handling device such as hook blocks, slings, etc., must be considered as part of the load and must be deducted from the lifting capacities.
5. Rated lifting capacities are based on freely suspended loads and make no allowance for such factors as the effect of wind, sudden stopping of loads, supporting surface conditions, inflation of tires, operating speeds, side loads, etc. Side pull on the boom or jib is extremely dangerous.
6. Rated lifting capacities do not account for wind on lifted load or boom. We recommend against working under the condition that the load is out of control due to a strong wind. During boom lift, consider that the rated lifting capacity is reduced by 50% when the wind speed is 20mph(9m/s) to 27mph(12m/s); reduced by 70% when the wind speed is 27mph(12m/s) to 31mph(14m/s). If the wind speed is 31mph(14m/s) or over, stop operation. During jib lift, stop operation if the wind speed is 20mph(9m/s).
7. Rated lifting capacities at load radius shall not be exceeded. Do not tip the crane to determine allowable loads.
8. Do not operate at boom lengths, radii, or boom angle, where no capacities are shown. Crane may overturn without any load on the hook.

9. When boom length is between values listed, refer to the rated lifting capacities of the next longer and next shorter booms for the same radius. The lesser of the two rated lifting capacities shall be used.
10. When making lifts at a load radius not shown, use the next longer radius to determine allowable capacity.
11. Load per line should not exceed 8,820 lbs. (4,000kg) for main hoist and auxiliary hoist.
12. Check the actual number of parts of line with LOAD MOMENT INDICATOR (AML-C) before operation. Maximum lifting capacity is restricted by the number of parts of line of LOAD MOMENT INDICATOR (AML-C). Limited capacity is as determined from the formula, Single line pull for main hoist 8,820 lbs.(4,000kg) x number of parts of line.
13. The boom angle before loading should be greater to account for deflection. For rated lifting capacities, the loaded boom angle and the load radius is for reference only.
14. The 31.8' (9.7m) boom length capacities are based on boom fully retracted. If not fully retracted [less than 40' (12.19m) boom length], use the rated lifting capacities for the 40' (12.19m) boom length.
15. Extension or retraction of the boom with loads may be attempted within the limits of the RATED LIFTING CAPACITIES. The ability to telescope loads is limited by hydraulic pressure, boom angle, boom length, crane maintenance, etc.
16. For lifting capacity of single top, reduce the rated lifting capacities of relevant boom according to a weight reductions for auxiliary load handling equipment. Capacities of single top shall not exceed 8,820 lbs. (4,000kg) including main hook.
17. When base jib or top jib or both jib removing, jib state switch select removed.
18. When erecting and stowing jib, be sure to retain it by hand or by other means to prevent its free movement.
19. Use "ANTI-TWO BLOCK" disable switch when erecting and stowing jib and when stowing hook block. While the switch is pushed, the hoist does not stop, even when overwind condition occurs.
20. For boom length with 23.6' (7.2m) jib, rated lifting capacities are determined by loaded boom angle only in the column headed "101.7' (31.0m) boom + 23.6' (7.2m) jib".
For boom length with 42' (12.8 m) jib, rated lifting capacities are determined by loaded boom angle only in the column headed "101.7' (31.0m) boom + 42' (12.8m) jib".
For angles not shown, use the next lower loaded boom angle to determine allowable capacity.
21. When lifting a load by using jib (aux. hoist) and boom (main hoist) simultaneously, do the following:
 - Enter the operation status as jib operation, not as boom operation.
 - Before starting operation, make sure that mass of load is within rated lifting capacity for jib.

DEFINITIONS

1. Load Radius: Horizontal distance from a projection of the axis of rotation to supporting surface before loading to the center of the vertical hoist line or tackle with load applied.
2. Loaded Boom Angle: The angle between the boom base section and the horizontal, after lifting the rated lifting capacity at the load radius.
3. Working Area: Area measured in a circular arc about the centerline of rotation.
4. Freely Suspended Load: Load hanging free with no direct external force applied except by the hoist line.
5. Side Load: Horizontal side force applied to the lifted load either on the ground or in the air.

GR-350XL RATED LIFTING CAPACITIES (IN POUNDS)

ON RUBBER																									
A	Stationary										Creep														
	Over Front					360° Rotation					Over Front														
	31.8'		55'		70'	31.8'		55'		70'	31.8'		55'		70'										
B	C	(9.7m)	C	(12.19m)	C	(21.34m)	C	(9.7m)	C	(12.19m)	C	(21.34m)	C	(9.7m)	C	(16.8m)	C	(21.34m)							
10'	60	41,400					60	24,400					60	32,000											
12'	56	37,900					56	18,200					56	27,800											
15'	49	27,000	68	24,500			49	12,400	68	13,200			49	22,800	68	21,900									
20'	34	16,800	62	15,700	69	16,450	33	7,200	62	7,850	68.8	7,900	34	16,800	63	15,700	69	16,450							
25'			56	10,700	64	11,700			56	4,700	64	4,750			56	10,700	64	11,700							
30'			49	7,500	60	8,450			49	2,900	59	2,900			49	7,500	60	8,450							
35'			42	5,100	55	6,200					54.3	1,700			42	5,100	55	6,200							
40'			32	3,650	49	4,500									32	3,650	49	4,500							
45'			19	2,400	43	3,300									19	2,400	43	3,300							
50'					36	2,400											36	2,400							
55'					28	1,600											28	1,600							
60'					16	1,200											16	1,200							
D	0					0					38					49					0				

LIFTING CAPACITIES AT ZERO DEGREE BOOM ANGLE ON RUBBER OPERATION																
A	Stationary										Creep					
	Over Front					360° Rotation					Over Front					
	31.8'		55'		70'	31.8'		55'		70'	31.8'		55'		70'	
C	B	(9.7m)	B	(16.8m)	B	(21.34m)	C	(9.7m)			B	(9.7m)	B	(16.8m)	B	(21.34m)
0	23.7'	11,900	46.9'	2,300	61.9'	1,000	23.7'	4,800			23.7'	12,100	46.9'	2,300	61.9'	1,000

- A : Boom length in feet
- B : Load radius in feet
- C : Loaded boom angle (°)
- D : Minimum boom angle (°) for indicated length (no load)

NOTE: The lifting capacity data stored in the LOAD MOMENT INDICATOR (AML-C) is based on the standard number of parts of line listed in the chart. Standard number of parts of line for rubber operation should be according to the following table.

Boom length in feet (meters)	31.8' (9.7m)	31.8' to 70' (9.7m to 21.34m)	Single top Jib
Number of parts of line	6	4	1

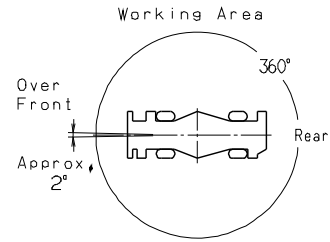

WARNING AND OPERATING INSTRUCTIONS FOR ON RUBBER LIFTING CAPACITIES

- Rated lifting capacities on rubber are in pounds and do not exceed 75 % of tipping loads as determined by SAE J765-Crane Stability Test Code.
- Rated lifting capacities shown in the chart are based on condition that crane is set on firm level surfaces with axle oscillation lockout applied. Those above bold lines are based on tire capacity and those below, on crane stability. They are based on actual load radius increased by tire deformation and boom deflection.
- If the axle oscillation lockout cylinders contain air, the axle will not be locked completely and rated lifting capacities may not be obtainable. Bleed the cylinders according to the operation safety and maintenance manual.
- Rated lifting capacities are based on proper tire inflation, capacity and condition. Damaged tires are hazardous to safe operation of crane.
- Tires shall be inflated to correct air pressure.
- Over front operation shall be performed within two degrees in front of chassis.
- On rubber lifting with "jib" is not permitted. Maximum permissible boom length is 70' (21.34m).
- When making lift on rubber stationary, set parking brake.
- For creep operation, boom must be centered over front of machine, swing lock engaged, and load restrained from swinging. Travel slowly and keep the lifted load as close to the ground as possible, and especially avoid any abrupt steering, accelerating or braking.
- Do not operate the crane while carrying the load.
- Creep is motion for crane not to travel more than 200' (60 m) in any 30 minute period and to travel at the speed of less than 1 mph (1.6km/h).
- For creep operation, choose the drive mode and proper gear according to the road or working condition.

Tires	Air Pressure
20.5-25	94 psi (650 kPa)

WARNING AND OPERATING INSTRUCTIONS FOR USING THE LOAD MOMENT INDICATOR (AML-C)

1. When operating crane on outriggers:
 - Set P.T.O. switch to "ON".
 - Press the outrigger mode select key to register for the outrigger operation. Press the register key, then the outrigger mode indicative symbol changes from flashing to a solid light
 - Press the lift mode select key to select the lift status that corresponds to the actual boom configuration. Each time the lift mode select key is pressed, the status changes. Press the register key to register the lift status, then the lift indicative symbol changes from flashing to a solid light.
 - when mounting and stowing jib, select the jib set status. (the jib state indicative symbol will be flashing.)
 2. When operating crane on rubber:
 - Set P.T.O. switch to "ON".
 - Press the outrigger mode select key. The on-tire mode indicative symbol comes on. Each time the outrigger mode select key is pressed the status changes. Select the creep operation, the on-tire mode indicative symbol flicker.
 - Press the lift mode select key to register the boom or single top lift.
- However, pay attention to the following.
- (1) For stationary operation.
 - The front capacities are attainable only when the over front position symbol comes on. When the boom is more than 2 degrees from centered over front of chassis, 360° capacities are in effect.
 - When a load is lifted in the front position and then swung to the side area, make sure the value of the LOAD MOMENT INDICATOR(AML-C) is below the 360° lifting capacity.
 - (2) For creep operation.
 - The creep capacities are attainable only when boom is in the straight forward position of chassis and the over front position symbol is on. If boom is not in the straight forward position of chassis, never lift load.
 3. A swing does not automatically stop even if the crane becomes overloaded.
 4. During crane operation, make sure that the displays on front panel are in accordance with actual operating conditions.
 5. The displayed values of LOAD MOMENT INDICATOR (AML-C) are based on freely suspended loads and make no allowance for such factors as the effect of wind, sudden stopping of loads, supporting surface conditions, inflation of tire, operating speed, side loads, etc. For safe operation, it is recommended when extending and lowering boom or swinging, lifting loads shall be appropriately reduced.
 6. LOAD MOMENT INDICATOR (AML-C) is intended as an aid to the operator. Under no condition should it be relied upon to replace use of capacity charts and operating instruction. Sole reliance upon LOAD MOMENT INDICATOR (AML-C) aids in place of good operating practice can cause an accident. The operator must exercise caution to assure safety.

GR-350XL Axle weight distribution chart

	Pounds			Kilograms		
	GVW	Front	Rear	GVW	Front	Rear
Base machine	60,830	30,380	30,450	27,590	13,780	13,810
Remove:						
1. 4.4 ton (4.0metric ton) hook ball	-220	-310	90	-100	-140	40
2. 35 ton (31.8metric ton) hook block	-620	-1,100	480	-280	-500	220
3. 2-stage jib (7.2m, 12.8m)	-1,390	-2,390	1,000	-630	-1,085	455
4. Auxiliary lifting sheave	-110	-270	160	-50	-122	72

TADANO AMERICA CORPORATION

4242 West Greens Road
Houston, Texas, 77066 U.S.A.
PHONE: (281) 869-0030
FAX: (281) 869-0040
<http://www.tadanoamerica.com>

Form No. TAC-GR-350XL-2-00101-2M2D-01132014